

Wireless Innovation Forum Webinar Series

Webinar #21: CBRS Baseline Standards
22 February 2018



Administrivia

Slides presented during this webinar are available in the handouts and will be posted here:

- <http://www.wirelessinnovation.org/webinars>

Recorded Webinar will be available on the Forum's You Tube Channel:

- <https://www.youtube.com/channel/UCYUeZvOujTTP27OzoKsyyS0w>

Email Lee.Pucker@wirelessinnovation.org if you need more information

Go To Webinar Interface

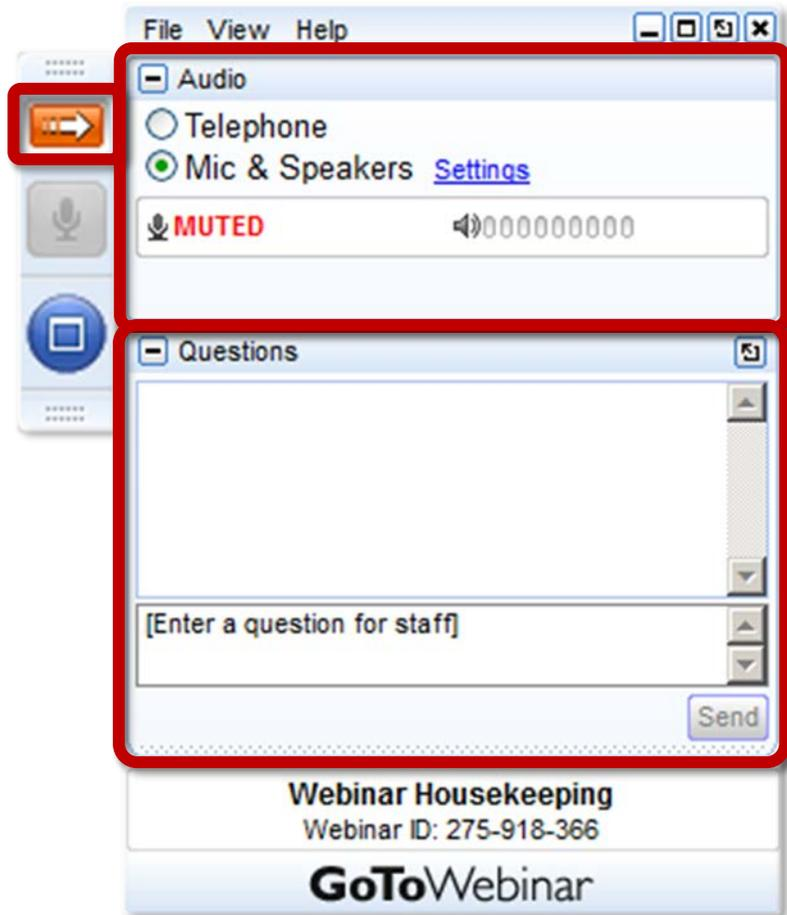

Your Participation

Open and close your control panel

Join audio:

- Choose **Mic & Speakers** to use VoIP
- Choose **Telephone** and dial using the information provided

Submit questions and comments via the Questions panel

Note: Today's presentation is being recorded and will be provided within 48 hours.

BACKGROUND: WHAT ARE THE BASELINE STANDARDS



Slide 4



What is Driving Dynamic Spectrum Sharing in the US

**Presidential Memorandum
“Unleashing the Wireless
Broadband Revolution”**

June, 2010



**NTIA “Fast Track
Report”**

October, 2010



**PCAST Report
July, 2012**

“America’s future competitiveness and global technology leadership depend, in part, upon the availability of additional spectrum.”

Directed NTIA to collaborate with the FCC to make available 500 megahertz of spectrum available for commercial wireless services while ensuring no loss of critical government capabilities



“In order to ensure that this global [technology] leadership continues and that the Administration’s goal of universal broadband is met, additional spectrum is needed for fixed and mobile wireless broadband systems.”

NTIA identified 3550-3650 MHz as one of several federal bands that could be made available for commercial wireless broadband by 2015.

“In the coming years, access to spectrum will be an increasingly important foundation for America’s economic growth and technological leadership.”

Concluded that the best way to increase the availability of broadband spectrum is to promote spectrum sharing between federal and commercial users through the use of new technologies...

Citizen's Broadband Radio Service (CBRS)

3-Tier Concept

Authorized Federal and Grandfathered FSS

Grandfathered Wireless Broadband

"Use It Or Share It"



Incumbent Primary Access

Priority Access License (PAL)

Licenses awarded by auction
Protected from GAA users, but must protect incumbents
Registers with and controlled by SAS

General Authorized Access (GAA)

Open eligibility
No interference protection
Registers and is controlled by SAS

Reverts to GAA in 2020



Band Plan

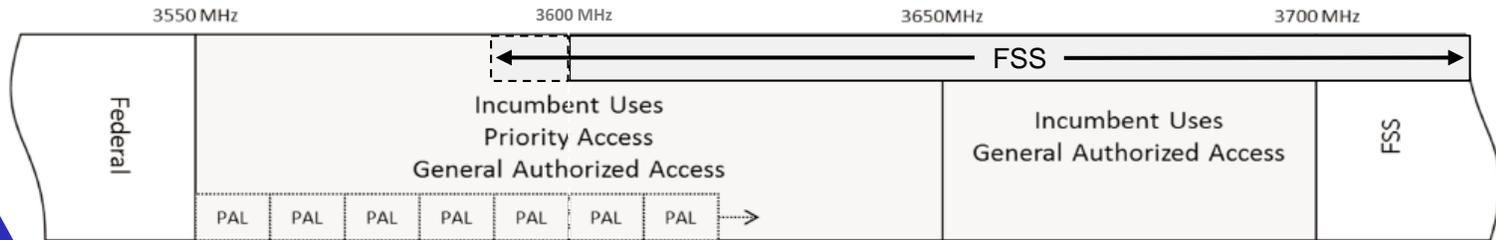

CBRS Use Cases



Use Cases	Embedded devices: FiOS, OnHub, Echo etc.	Neutral In-building wireless	Enterprise owned deployments	Smart Cities & Outdoor	Fixed Wireless
Key Driver	Control of QoS; Assured delivery of content	Revenue expansion opportunity – Neutral Host	Piggyback on WiFi; Potential services via MVNO(?)	Infrastructure Buildout – Smart Cities initiatives, IoT etc.	Infrastructure Buildout: un- and under-served areas
Verticals	Homes, SOHO, SMBs	Public venues: Hotels, Hospitals, MDUs etc.	Enterprises	Outdoor: Street poles, Booths (LinkNYC), Manhole covers, Billboards etc.	Residential, SMB's, Venues, Retail, Enterprise, Education, Government, Hospitality and more
ROM Market Size	Millions of units	Urban Buildings: 10s of thousands of buildings	100,000's of units	Millions of units	Millions of units

Adopting the PCAST Model: Time Line for CBRS Regulations

2013	2014	2015	2016
<p>Notice of Public Rule Making</p> <p>3.5 GHz Workshop</p> <p>Public Notice on 3.5 GHz Licensing Framework</p>	<p>Further Notice of Proposed Rule Making</p>	<p>Report and Order and Second Further Notice of Proposed Rule Making</p> <p>Public Notice on Protection of Grandfathered 3650 to 3700 MHz Licensees</p> <p>First Wave Applications for SAS Administrators and ESC Operators</p>	<p>Order on Reconsideration and Second report and Order</p> <p>Methodology Adopted on Protection of Grandfathered 3650 to 3700 MHz Band Licensees</p> <p>Conditional Approval of SAS Administrators</p>



Addressing the Need for a “Multi-stakeholder Group”

The Wireless Innovation Forum is a nonprofit “mutual benefit corporation” dedicated to:

“advancing technologies supporting the innovative utilization of spectrum and the development of wireless communications systems, including essential or critical communications systems”



What role does the Forum play?

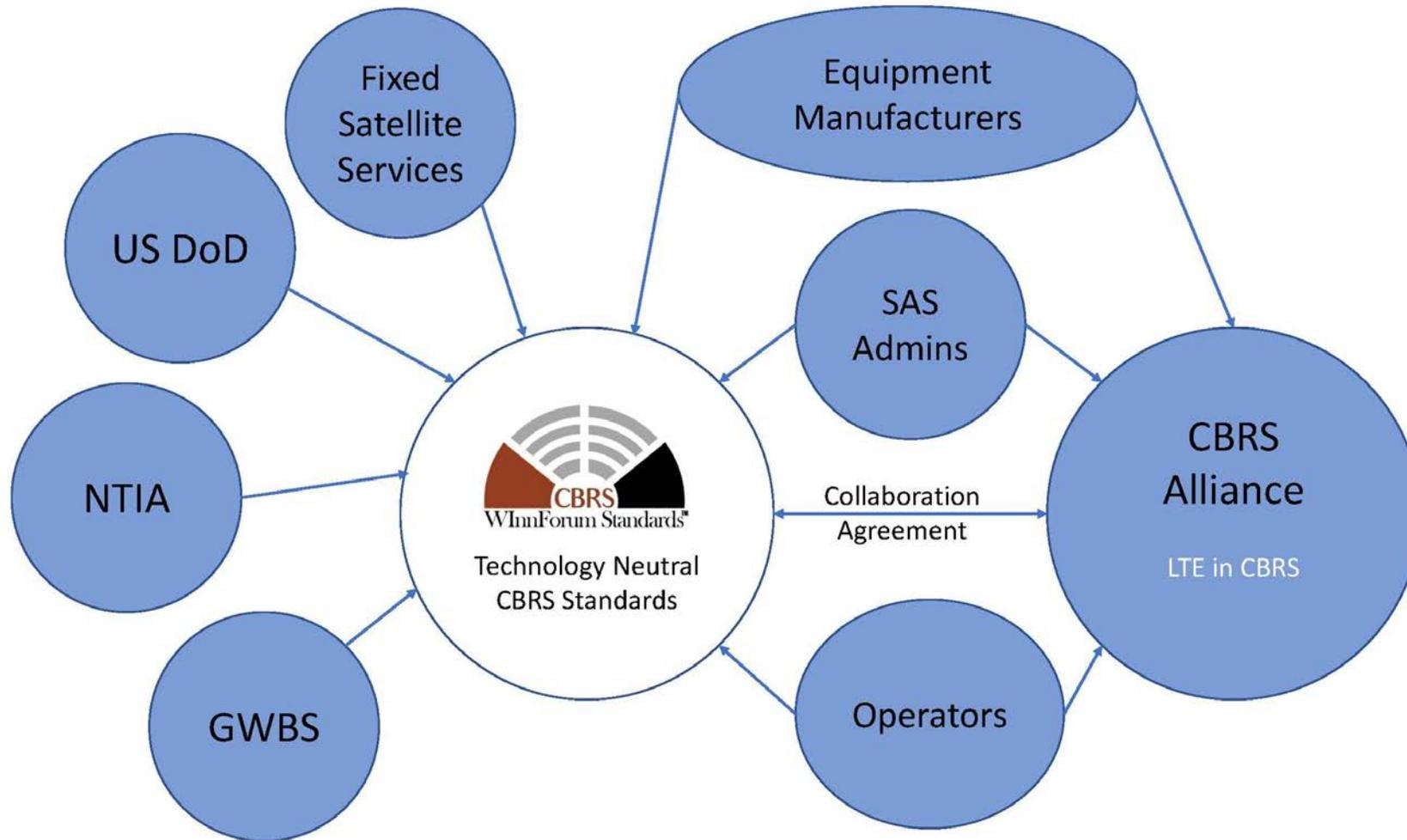

CBRS Standards Development Within the Forum: 250+ Participants, 60+ Organizations



And many more...



Spectrum Sharing Committee Structure

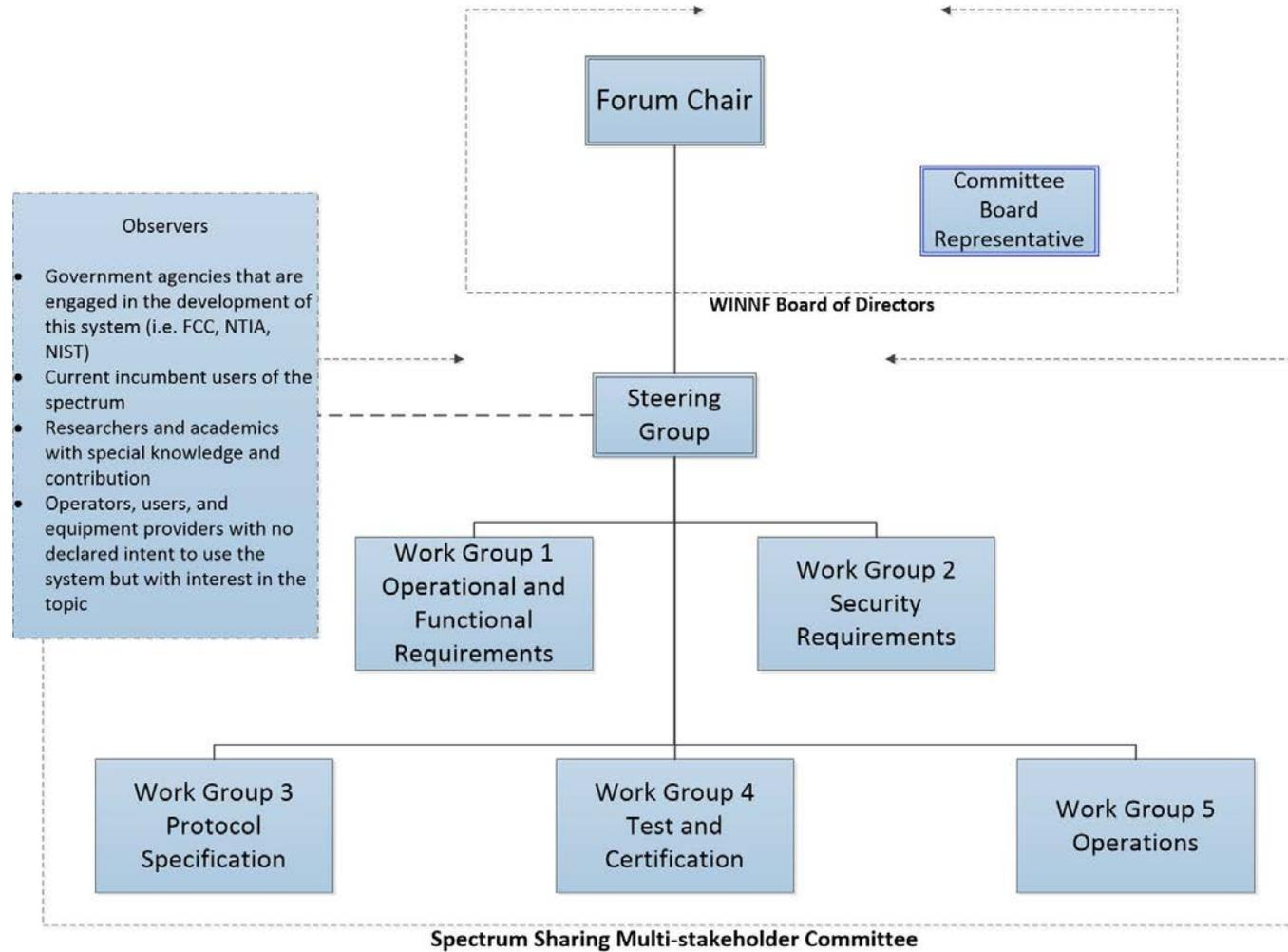

Commercializing CBRS: Standards and Ecosystem Support

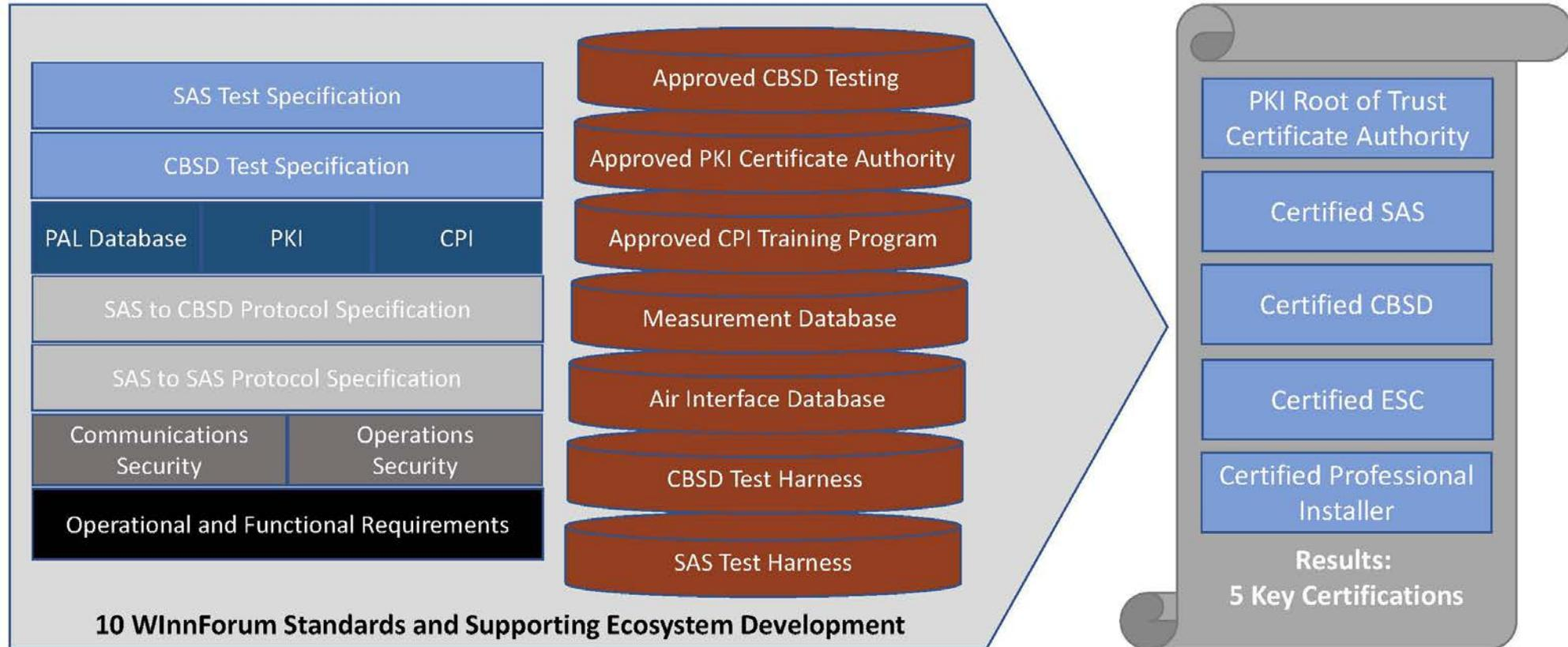

Today's Agenda

Welcome and introductions - Lee Pucker, The Wireless Innovation Forum

Requirements - Andy Clegg, Google

Protocols

- SAS to CBSD - Mike Dolan, Nokia
- SAS to SAS - Yi Hsuan, Google

Test and Certification

- SAS - Masoud Olfat, Federated Wireless
- CBSD - Awaiz Khan, Ruckus Wireless

Operations - Richard Bernhardt, WISPA

- CA
- CPI
- Other



Today's Agenda

Welcome and introductions - Lee Pucker, The Wireless Innovation Forum

Requirements - Andy Clegg, Google

Protocols

- SAS to CBSD - Mike Dolan, Nokia
- SAS to SAS - Yi Hsuan, Google

Test and Certification

- SAS - Masoud Olfat, Federated Wireless
- CBSD - Awaiz Khan, Ruckus Wireless

Operations - Richard Bernhardt, WISPA

- CA
- CPI
- Other



Operational and Functional Requirements

Requirements

FCC sets the rules for operation within CBRS

CBRS rules are contained in Part 96 of Title 47 of the Code of Federal Regulations (CFR), referred to as simply Part 96

By law, all SAS, ESC, CBSDs, and EUDs must comply with Part 96

Part 96 by itself does not contain sufficient detail to create a fully interoperable and standardized CBRS ecosystem

WinnForum has created a high-level functional and operational requirements specification that standardizes CBRS operation



Operational and Functional Requirements

Topical Areas within the Operational and Functional Requirements Standard

- Definitions and Abbreviations
- SAS Requirements
- PAL Requirements
- CBSD and EUD Requirements
- Domain Proxy Requirements
- System Registration Requirements
- ESC Requirements
- CPI Requirements



Operational and Functional Requirements

The Requirements form the foundation for WInnForum CBRS protocols and for the functional tests against which SASs and ESCs will be certified

The Requirements are also the basis of the tests for WInnForum-approved CBSD test program used by CBSD certification labs

Operational and Functional Requirements

Among the key standardized Requirements:

- CBSD registration
- Implementation of incumbent protections
- Propagation models
- Aggregate interference calculation
- Information exchange among elements of the CBRS ecosystem (SAS-CBSD, SAS-SAS)
- Computation of PAL protection areas
- ESC performance criteria
- Implementation of the Certified Professional Installer program

Propagation

- **Two propagation models for first-generation SASs:**
 - Irregular Terrain Model (ITM), point-to-point mode
 - Relatively conservative model
 - Used for protection of federal government systems, fixed-satellite service (FSS) earth stations, and ESC sensor nodes
 - Hybrid model based on eHata and ITM
 - Ostensibly based on prop model used for NTIA exclusion zone analysis (Appendix A of NTIA 15-517)
 - Includes some general considerations for clutter
 - Used for determination and protection of PAL Protection Areas (PPAs) and Grandfathered Wireless Protection Zones (GWPZs)
 - Defaults to ITM for PPA and GWPZ in rural areas

Aggregate Interference

- **All interference calculations are based on the aggregate of interference from CBSDs**
 - For non-federal-government protection, considers CBSDs within 40-150 km, depending on protected entity and type of CBSD
 - Federal government protection distances still being finalized
 - Aggregate interference calculations must ensure a result that is at least as conservative as Monte Carlo methods defined in the Requirements, where, essentially, the random variable is the ITM reliability factor (for the ITM model) or the situation-dependent log-normal distribution (for the eHata model)
 - For zone-based protections of non-federal incumbents, the aggregate interference is computed across a standard 2" grid (even arc secs in lat/lon)
 - For protecting (dynamic) federal incumbents, a move list is generated per channel. Generally speaking, CBSDs are rank-ordered by their impact on interference, and the fewest number/greatest contributors are the ones targeted for re-accommodation to mitigate predicted interference in a channel when federal incumbents are active

Protection of Federal Incumbents

- Offshore region is divided into “Dynamic Protection Areas” (DPAs)
- Each DPA is monitored by one or more ESC sensors
- When federal incumbent activity is detected in a DPA, the entirety of the DPA is protected from aggregate interference to a pre-defined level
- CBSDs that may impact interference in the DPA are reconfigured accordingly
- DPAs may be used to protect some inland sites

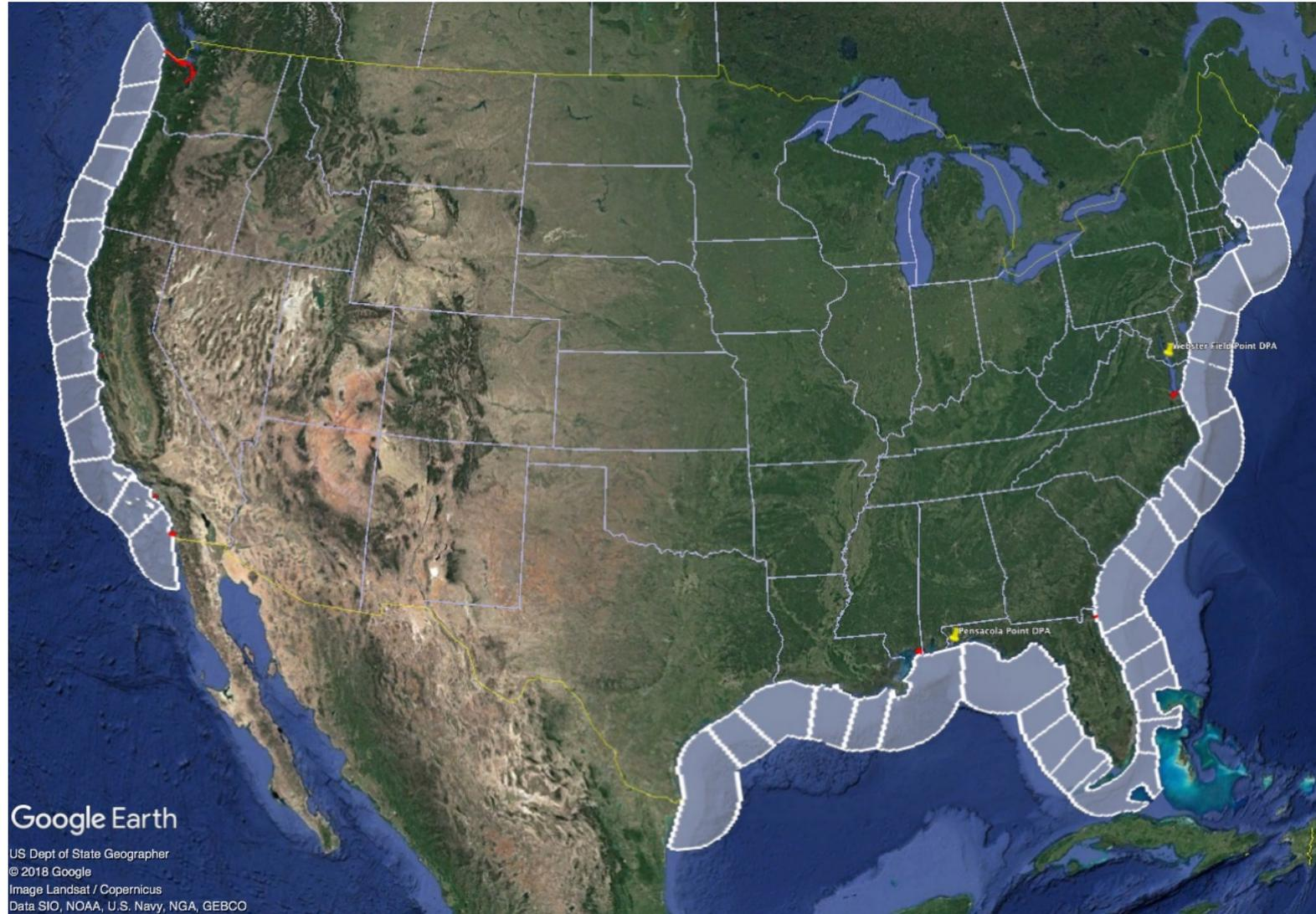

Slide 22

Protection of Non-Federal Incumbents

- **FSS (in-band and adjacent band) are protected to FCC-mandated levels**
 - Based on prop models and aggregate interference methods detailed in the Requirements
 - All in-band (3600-3700 MHz) FSS are protected, as are adjacent-band (>3700 MHz) sites used for TT&C
 - Reference FSS antenna pattern and filter are included in interference calculation
 - FSS are required to register their actual operating parameters and are protected by SAS in accordance with those parameters.
 - SAS will ingest FSS data on regular basis. Awaiting implementation of FCC API.
- **Part 90 devices (such as WISPs and Utilities) are protected until sunset period**
 - FCC has required operators to register their base stations and operating sectors. These are the Grandfathered Wireless Protection Zones (GWPZs).
 - GWPZs are protected per the area protection standard and based on specified prop models and computed aggregate interference
 - Most GWPZs sunset in April 2020; some remain until January 2023

Iterative Allocation Process (IAP)

The following Protected Entities are protected through IAP

- PPA, GWPZ, ESC Sensors, and FSS (Co-channel and Blocking)

IAP is a iterative process through which the SASs cooperate to allocate the interference budget to all CBSDs impacting certain Protected entities, fairly.

IAP is applied to a group of CBSDs located within a certain area around a protected entity (Neighborhood Protection Area), and are co-channel to the entity.

Each CBSD is allocated a minimum interference budget out of the protection threshold of an entity, and an iterative process is followed to allocate the remaining budget to all CBSDs

The outcome of IAP is allocated EIRP per each CBSD

SAS Administrators have agreed to perform IAP synchronously in a periodic fashion through a process called Coordinated Periodic Activates among SASs(CPAS)

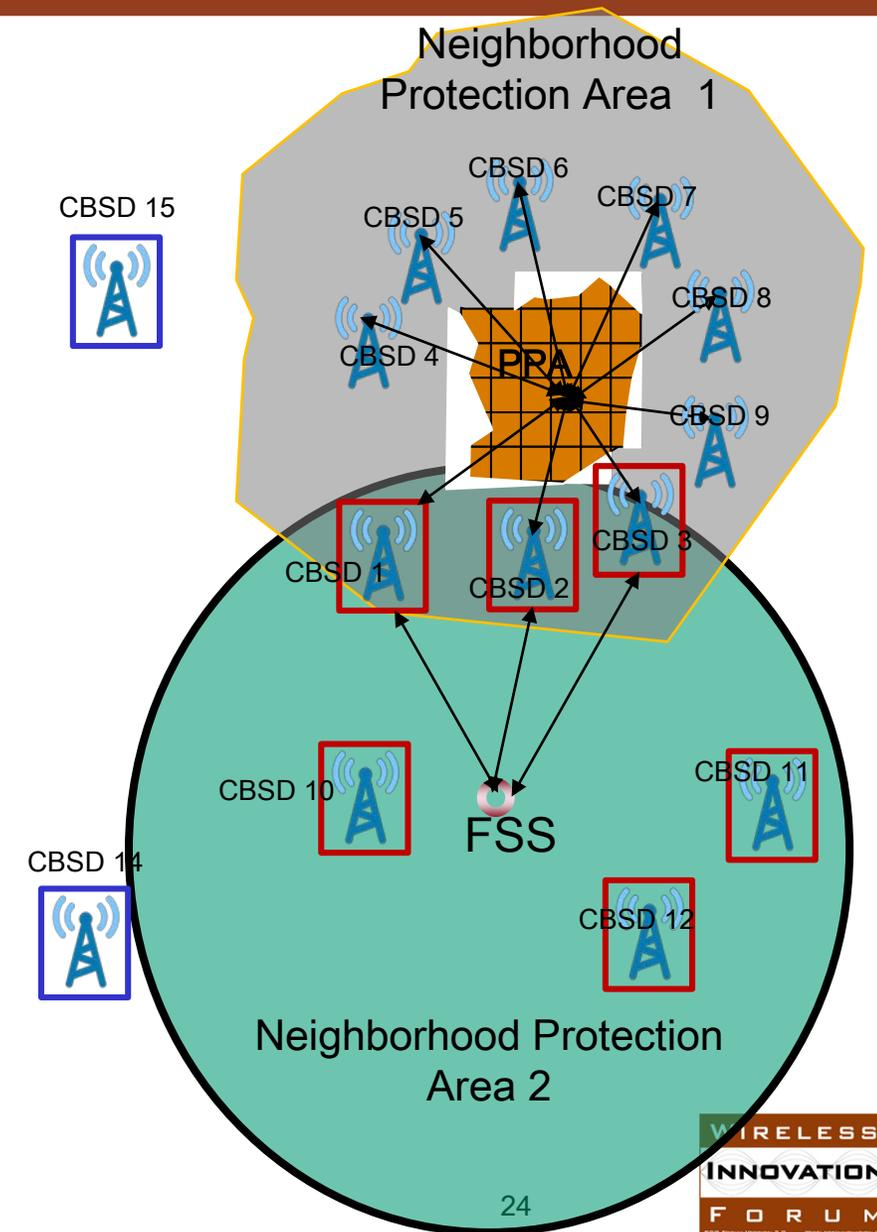

FSS Protection

- Zones surrounding in-band FSS sites in which CBRS impact on co-channel FSS must be considered
- Protected in all or portions of 3600-3700 MHz
- Point protections based on actual location of FSS earth station
- Aggregate interference, propagation model, and reference FSS antenna/filter per spec

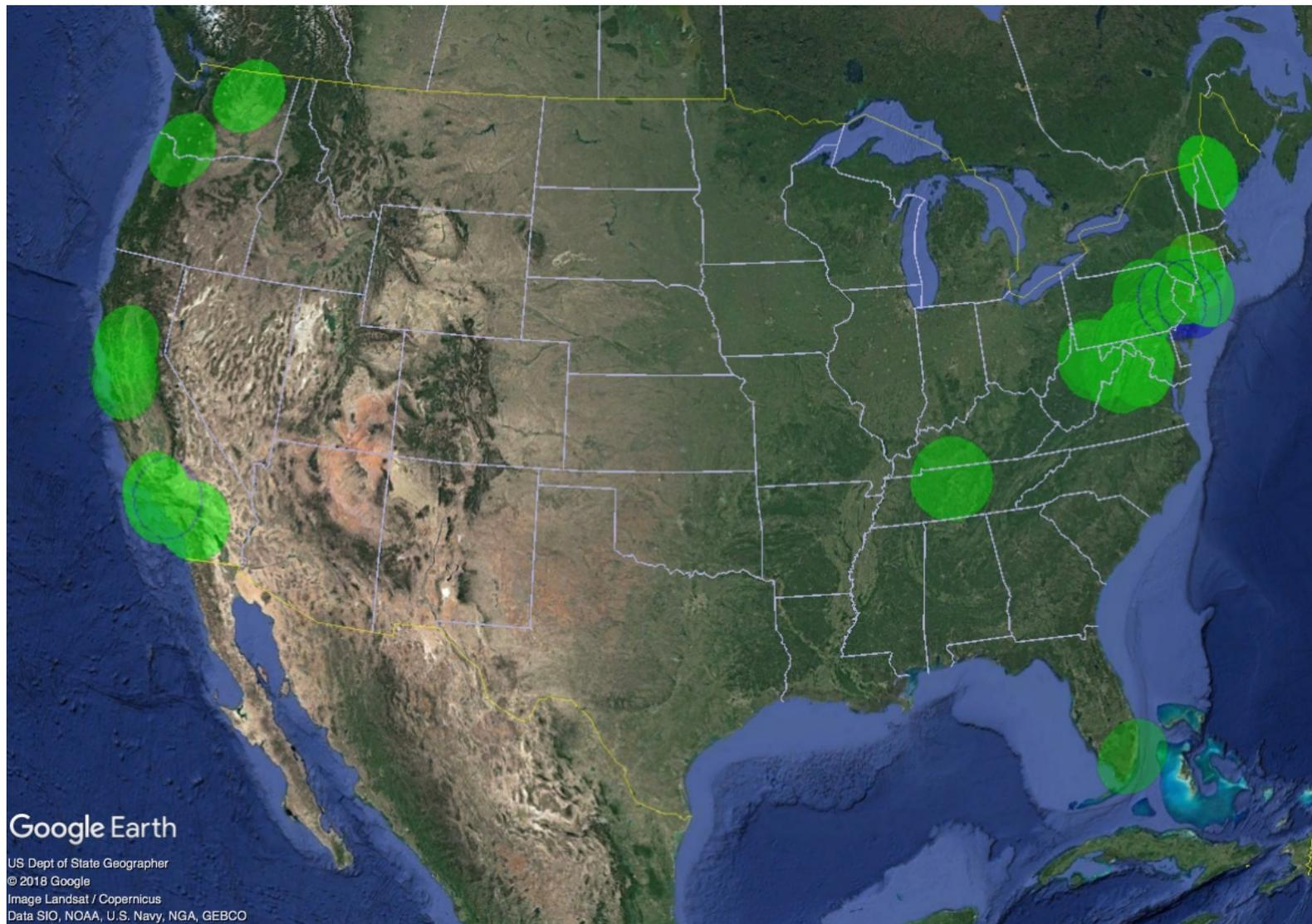

Slide 25

Grandfathered Wireless Protection Zones

- Grandfathered Wireless Protection Zones (red)
- Protected in all or portions of 3650-3700 MHz
- Protections based on aggregate interference, prop model, and 2" grid per spec
- CBSDs out to 40 km from GWPZ are considered

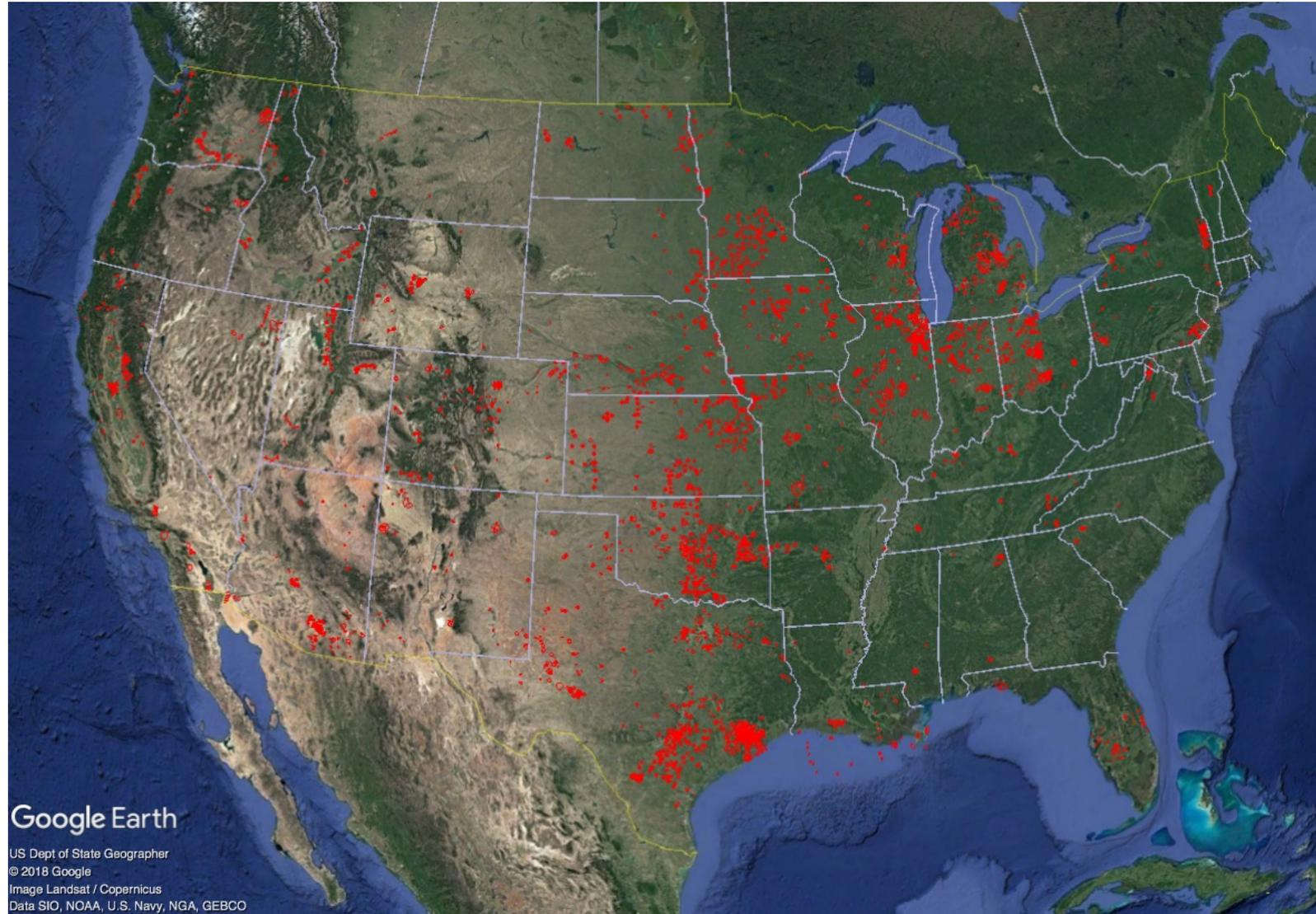

Slide 26

Requirements Standard

- **Many other topic areas covered in great detail in the Requirements Technical Specification**
- **Please refer to WINNF-TS-0112, available for free on the WinnForum website**

Today's Agenda

Welcome and introductions - Lee Pucker, The Wireless Innovation Forum

Requirements - Andy Clegg, Google

Protocols

- **SAS to CBSD - Mike Dolan, Nokia**
- SAS to SAS - Yi Hsuan, Google

Test and Certification

- SAS - Masoud Olfat, Federated Wireless
- CBSD - Awaiz Khan, Ruckus Wireless

Operations - Richard Bernhardt, WISPA

- CA
- CPI
- Other



REGISTRATION

A CBSD is initially in the “UNREGISTERED” state and must register with the SAS by sending a Registration Request Message to the SAS including:

- All installation parameters describing the CBSD’s power capabilities, location, and antenna characteristics.

The SAS returns a Registration Response Message with a SUCCESS indication when it has received all necessary installation information directly from the CBSD or through other means.

A CBSD remains registered, even if it is powered off, until:

- Its location changes – causing the CBSD to re-register, or
- Its antenna characteristics change – causing the CBSD to re-register, or
- It is told by the SAS to deregister for one of several reasons, or
- The CBSD sends a Deregister Request Message to the SAS.

Once a CBSD is REGISTERED, the CBSD may request a Spectrum Grant for operation in the CBRS spectrum range. (next slides)

SAS to CBSD Protocol



OBTAINING A SPECTRUM GRANT FROM THE SAS

After the CBSD is registered, it must request a Spectrum Grant from the SAS.

- A Grant Request Message is sent to the SAS indicating the spectrum range the CBSD would like to use and the maximum power level it would like to use.
- If the SAS determines that the requested spectrum range and power level are acceptable, it sends a Grant Response Message with a SUCCESS indication. At that point the CBSD has received a Grant, but is not yet allowed to transmit. The Grant has an associated expiration time.
- If the SAS determines that the requested spectrum range and power level are not acceptable, it will send a Grant Response Message indicating that the request is rejected. The SAS may send information on an alternate spectrum range and/or maximum power level that it may be able to accept.

SAS to CBSD Protocol



OBTAINING PERMISSION TO TRANSMIT FROM THE SAS

After the CBSD has a Grant, it must request permission to transmit from the SAS.

- A Heartbeat Request Message is sent to the SAS requesting permission to transmit.
- When the SAS returns a Heartbeat Response Message with a SUCCESS indication, the SAS also indicates a Transmit Expire Time and may indicate a Heartbeat Interval.
 - The Transmit Expire Time provides a means for the SAS to insure that the CBSD will not transmit beyond a certain point, unless the SAS updates the Transmit Expire Time in a subsequent Heartbeat Response Message.
 - The Heartbeat Interval is a target interval between Heartbeat Request Messages from the CBSD to allow the SAS some level of load control.
- The CBSD must continue sending Heartbeat Request Messages and receiving SUCCESS indications to continue transmitting and to extend the Transmit Expire Time.

SAS to CBSD Protocol



SPECTRUM GRANT SUSPENSION AND TERMINATION

When the SAS determines that the CBSD must stop transmitting on a given Grant, it returns a Heartbeat Response Message with a SUSPENDED indication.

- The CBSD's Grant moves from the Authorized state to the Grant Received state. The CBSD still has the Grant, but is no longer authorized to transmit. The CBSD must continue sending Heartbeat Request Messages until it receives a SUCCESS indication before it can begin transmitting again.

When the SAS determines that the Grant is no longer available to the CBSD (for a variety of reasons), it returns a Heartbeat Response Message with a TERMINATED indication.

- The CBSD moves to the Idle state. Note: The CBSD may have other Grants that may be in either the Grant Received state or the Authorized state. The Grant termination applies only to a single Grant. NOTE: A CBSD may also Relinquish a Grant.

SAS to CBSD Protocol

REGISTERED,
IDLE

GRANT
RECEIVED

AUTHORIZED
TO TRANSMIT

SPECTRUM INQUIRY

Once a CBSD is Registered, it may send a Spectrum Inquiry Request Message in any of the states shown above.

- A Spectrum Inquiry Request Message indicates one or more spectrum ranges that the CBSD is interested in.
- The SAS returns a Spectrum Inquiry Response Message with an indication of a set (0 or more) of:
 - A frequency range that the CBSD may be able to use,
 - The maximum power that the CBSD may be able to use in that frequency range, and
 - An indication of whether that frequency range would be a PAL or GAA channel with respect to the CBSD.
- There is no guarantee that the frequency range will be available if the CBSD requests it.

Protocol Messages

All Request messages are sent by the CBSD. All Response messages are sent by the SAS, and only in reply to a Request message.

- **Registration Request** – Carries the identity, category, and owner of the CBSD, also the location, antenna characteristics (height, azimuth, downtilt, gain, etc.), air interface type, and maximum power capability.
- **Registration Response** – Indicates whether the registration was successful.
- **Spectrum Inquiry Request** – Used to inquire about the availability of spectrum grants in one or more ranges.
- **Spectrum Inquiry Response** – Provides information on available spectrum grants, including whether a particular grant would be PAL or GAA for the requesting CBSD.
- **Grant Request** – Requests a spectrum grant over a particular frequency range and at a specific maximum power.
- **Grant Response** – Indicates whether a grant request was successful. It may include a hint at a possible alternate spectrum grant that might be available.

Protocol Messages - continued

- **Heartbeat Request** – Indicates to the SAS that the CBSD continues use of the spectrum grant. It may also carry measurement information and a request to extend the life of the grant.
- **Heartbeat Response** – Indicates whether the CBSD is allowed to begin/continue transmission using a specific grant request, and until what time. It may also include a grant lifetime extension, a hint at a possible alternate spectrum grant that might be available, and a request that the CBSD perform measurements it is capable of.
- **Relinquishment Request** – Used to relinquish use of a spectrum grant.
- **Relinquishment Response** – Used by the SAS to acknowledge relinquishment of a grant.
- **Deregistration Request** – Requests that the SAS remove the registration for the CBSD. Any grants the CBSD may have are also relinquished.
- **Deregistration Response** – Used by the SAS to acknowledge deregistration of the CBSD.

Today's Agenda

Welcome and introductions - Lee Pucker, The Wireless Innovation Forum

Requirements - Andy Clegg, Google

Protocols

- SAS to CBSD - Mike Dolan, Nokia
- **SAS to SAS - Yi Hsuan, Google**

Test and Certification

- SAS - Masoud Olfat, Federated Wireless
- CBSD - Awaiz Khan, Ruckus Wireless

Operations - Richard Bernhardt, WISPA

- CA
- CPI
- Other



SAS-SAS Protocol: Purpose

- Multiple SAS administrators may operate in the same area with their own managed CBSDs while jointly performing protection required by Part 96.
- To calculate and manage aggregate interference from all CBSDs toward a protected entity, each SAS needs to acquire relevant CBSDs information from other SASs.
- FCC Part 96.55 (a)(2): SAS Administrators must make all information necessary to effectively coordinate operations between and among CBSDs available to other SAS Administrators.

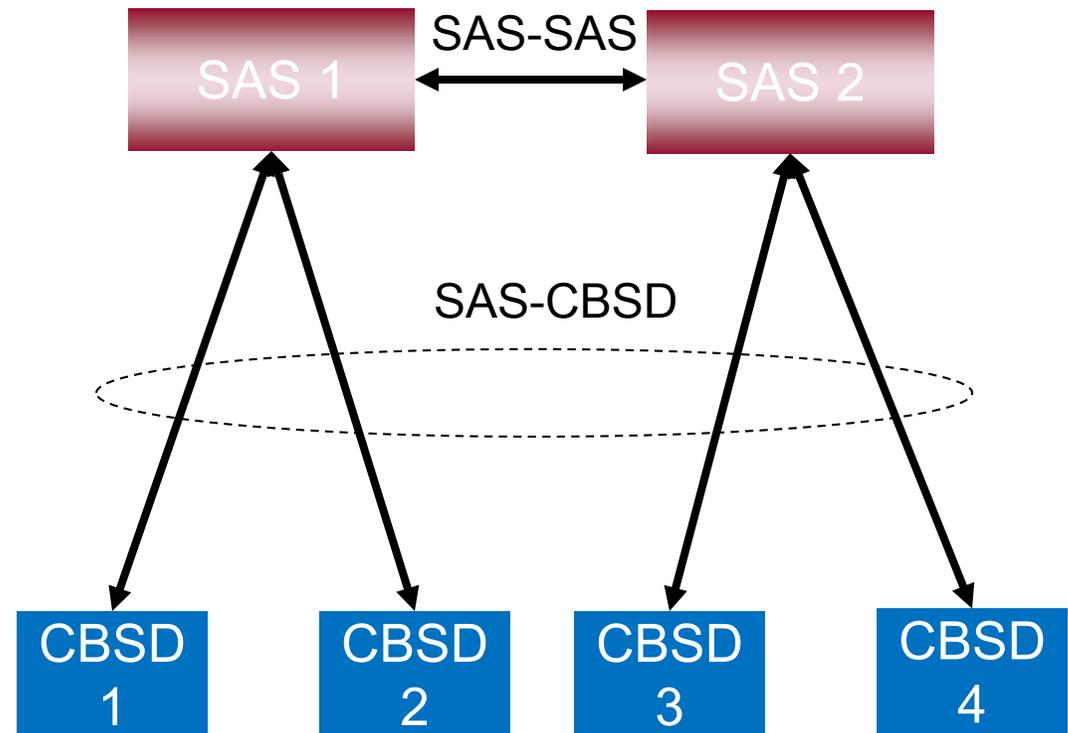

SAS-SAS Protocol: Record Types

Record Type	Description
SAS Administrators	SAS Administrator specific information like ID and contact information
SAS Implementations	Information of a particular SAS implementation like URL and FCC certification
CBSD	Registration & Grant information of CBSDs registered in a SAS
ESC Sensors	ESC Sensor locations, antenna characteristics, and protection level required to protect ESC sensors
Zones	Geographical areas known to the SAS requiring protection (e.g. PPAs)
Coordination events	Information regarding a wide range of events, such as GAA/FSS arrangements, PAL-to-PAL arrangements, enforcement actions by FCC, etc
Full activity dump	A full record dump by a SAS including all records on CBSD, Zone, and ESC under its control

SAS-SAS Protocol: Record Exchange Flow

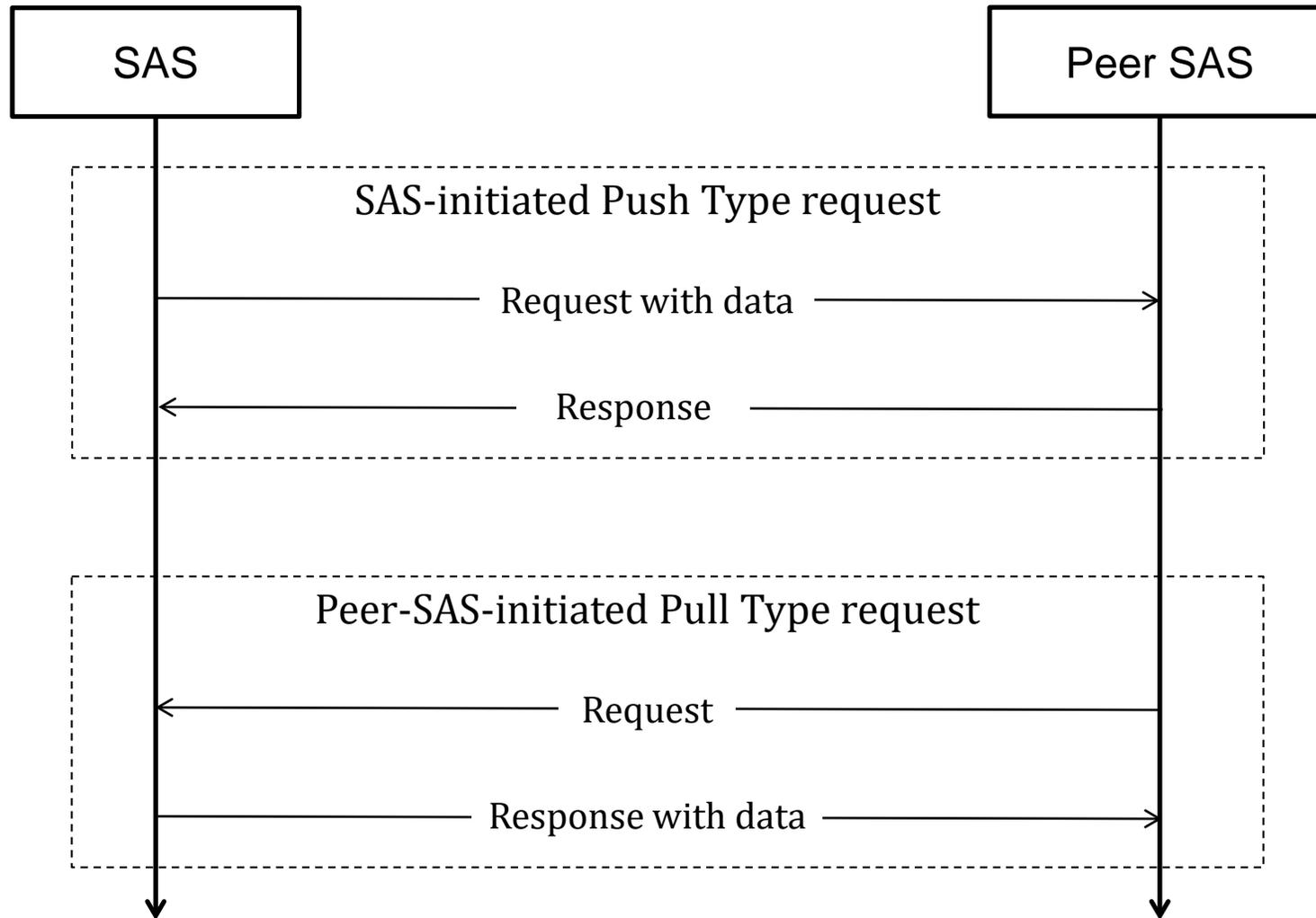

SAS-SAS Protocol: Synchronization Method

- **Full Record Dump**
 - A SAS prepares a full record dump including CBSD, Zone, and ESC Sensors records
 - A SAS provides access to full record dump data upon request
 - Dump data are available for at least 14 days
- **Time-range Request**
 - A SAS may periodically make time-range record requests to every peer SAS to update its information
 - Each SAS can maintain most updated status with smaller and more frequent data exchanges from peer SASs
- **By-ID Request**
 - If supported, a SAS shall return the most current details corresponding to the requested record when requested by a peer SAS
- **Support for Pull and Push Requests**
 - Pull requests are mandatory and push requests are optional
 - Push requests include time-range push and by-ID push

SAS-SAS Protocol: Data Objects

CbsdData object

Field	Data Type	Definition
id	string	CBSD ID
registration	object: RegistrationRequest	CBSD registration information
grants	Array of object: GrantData	CBSD grant information

EscSensorData object

Field	Data Type	Definition
id	string	ESC sensor ID
installationParam	object: InstallationParam	ESC installation parameters
protectionLevel	number	ESC sensor interference protection level

ZoneData object

Field	Data Type	Definition
id	string	Zone ID
name	string	Human-readable name of the zone
creator	string	Human-readable name of the zone creator
usage	string	Type of zone, e.g., PPA
terminated	boolean	Indicate whether the zone is valid or not
ppaInfo	object: PPAInformation	Additional information if the zone is a PPA
zone	object: GeoJSON	Geometry description of the addressed zone

SAS-SAS Protocol: Full Activity Dump

FullActivityDump object

Field	Data Type	Definition
files	Array of ActivityDumpFile	Array of objects corresponding to files comprising the dump
generationDateTime	string	Time at which the dump is generated
description	string	Additional description attached by SAS

ActivityDumpFile object

Field	Data Type	Definition
url	string	The retrieval URL where the peer SAS can retrieve the activity dump file
checksum	string	SHA-1 checksum of the file content
size	number	File size in bytes
version	string	Version of the SAS-SAS protocol
recordType	string	Type of record contained in the activity dump file, e.g., cbsd, zone, etc.

SAS-SAS Protocol: Synchronization Using Full Activity Dump

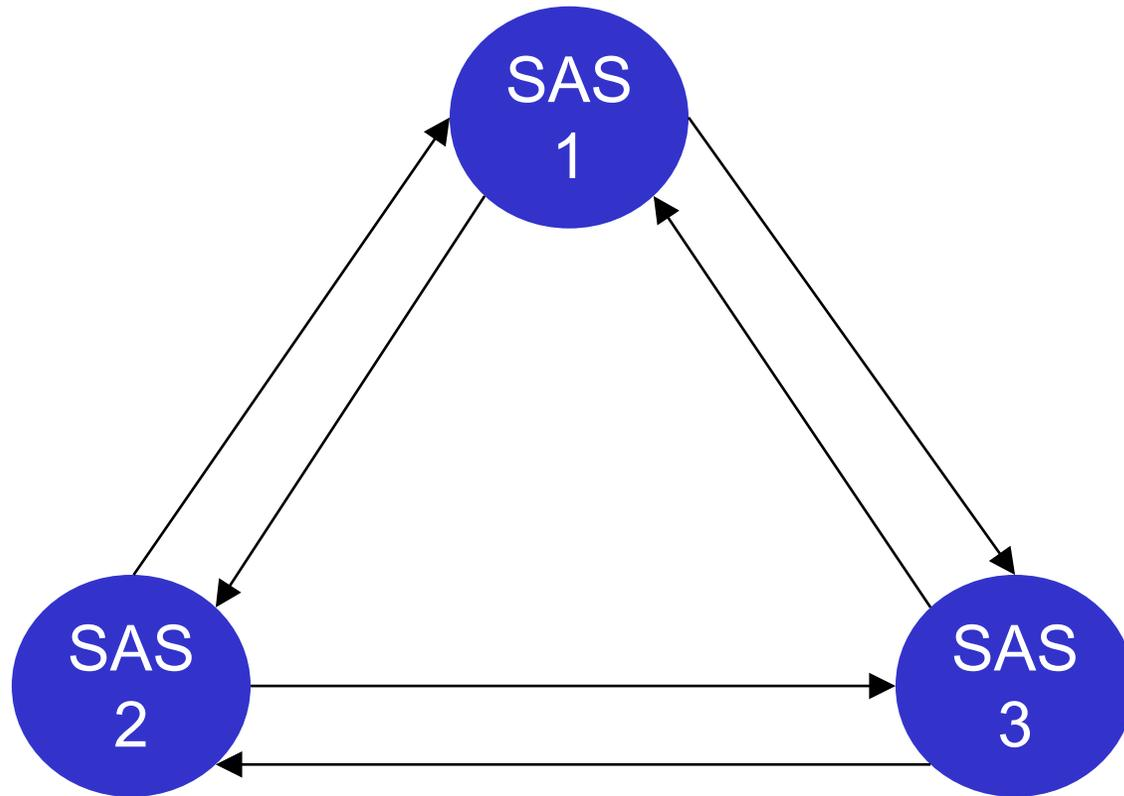

T_1 : time for each SAS to start the generation of a Full Activity Dump Record

T_2 : time for each SAS to pull Full Activity Dump Record from all other SASs

After T_2 : SASs perform Part 96 functions independently until the next synchronization time

Today's Agenda

Welcome and introductions - Lee Pucker, The Wireless Innovation Forum

Requirements - Andy Clegg, Google

Protocols

- SAS to CBSD - Mike Dolan, Nokia
- SAS to SAS - Yi Hsuan, Google

Test and Certification

- **SAS - Masoud Olfat, Federated Wireless**
- CBSD - Awaiz Khan, Ruckus Wireless

Operations - Richard Bernhardt, WISPA

- CA
- CPI
- Other

SAS Certification Program

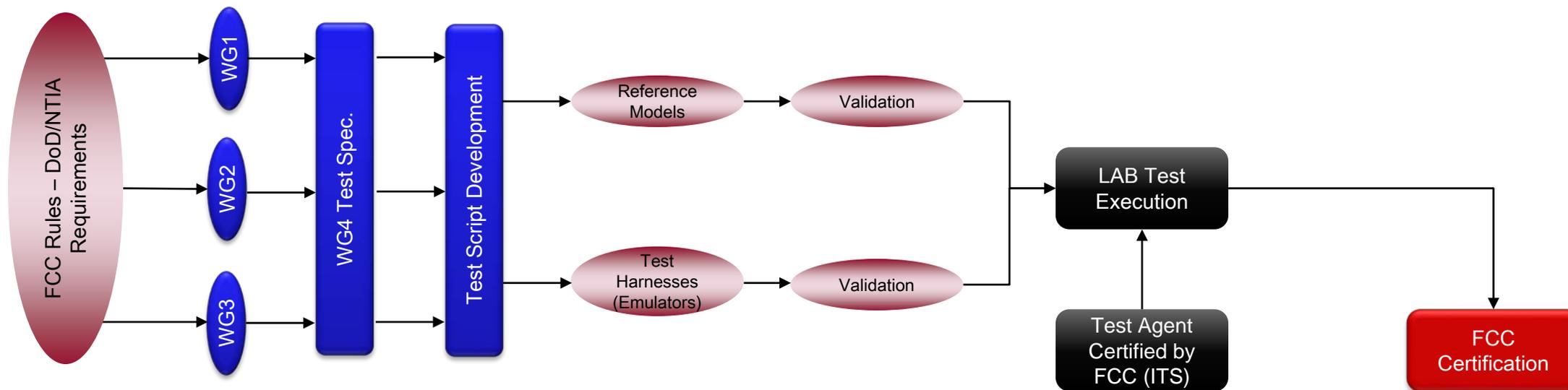

During Public Test Period, and before commercial deployment, the SAS Unit Under Test (UUT) may undergo field and IOT testing as per agreement with FCC and ITS.

WG4 Test Specification

Protocol Testing

- Include test cases to verify correct implementation of SAS-CBSD and SAS-SAS interfaces by the SAS UUT
- SAS-CBSD
 - Registration
 - Spectrum Inquiry
 - Grant Request Procedure
 - Heartbeat Procedure
 - Grant Relinquishment Procedure
 - Deregistration Procedure
 - CBSD Device Security Validation
 - Domain Proxy Security Validation
- SAS-SAS
 - Full Activity Exchange Procedure
 - SAS-SAS Security, Authentication, and Encryption Protocols

Model Testing

- Include test cases to test the correct implementation of the following models by the SAS UUT
- Path Loss based on Propagation Model defined by to WG1
 - ITM Model
 - Extended Hata Model
 - Hybrid model
- FSS Receive Antenna pattern according to WG1
- CBSD Antenna pattern

Functional Testing

- Includes test cases to ensure the functionalities implemented in the SAS UUT conform to WinnF specifications, and FCC/DoD requirements
 - Exclusion Zone test cases
 - PPA (PAL Protection Area) Creation
 - Single Entity general Aggregate Interference Protection (through Iterative Allocation Process)
 - ESC Protection
 - PAL Protection
 - GWPZ (Grandfather Wireless Protection Zone) Protection
 - FSS (Fixed Satellite Station) Protection
 - Federal Incumbent Protection
 - Multiple Protection Points Protection
 - Federal and WinnF DataBase
 - International Border Protection
 - Quiet Zone Protection

Test Harness

Main Test Harness

- A collection of routines configured by the test operator to interact with the SAS UUT in order to execute the test cases, including reference models, and other Test Harnesses

SAS Test Harness

- A collection of routines configured by the test operator to interact with the SAS UUT via SAS-SAS interface, in order to automate critical test sequences and procedures. Via this interface, the SAS Test Harness emulates the SAS-SAS Protocol Messages

CBSD Test Harness

- A collection of routines configured by the test operator to interact with the SAS UUT via SAS-CBSD interface, in order to automate critical test sequences and procedures. Via this interface, the CBSD Test Harness emulates the SAS-CBSD Protocol Messages generated by one CBSD, using a TLS connection with CBSD certificate to the SAS UUT.
- If multiple CBSD Test Harnesses are directly connected to the SAS UUT, each has its own TLS connection to the SAS UUT.

Test Harness

DP (Domain Proxy) Test Harness

- A collection of routines that configured by the test operator to interact with the SAS UUT via SAS-CBSD interface, in order to automate critical test sequences and procedures. Via this interface, the DP Test Harness emulates the SAS-CBSD Protocol Messages by one or more CBSDs, using a TLS connection with DP certificate to the SAS UUT.
- If multiple DP Test Harnesses are connected to the SAS UUT, each has its own TLS connection to the SAS UUT.
- The DP function within the DP Test Harness aggregates SAS-CBSD Request Messages of multiple single CBSDs and disaggregates the respective Response Messages of the SAS UUT

ESC Test Harness

- A collection of routines configured by the test operator to interact with the SAS UUT in order to execute the ESC functionalities of the test cases. Via this interface, the ESC Test Harness emulates the messages that would be sent from an ESC system to a SAS.

Admin Test Harness

- A collection of routines configured by the test operator to inject data that is required for the purpose of the test cases, into the SAS UUT.
- The Admin Test Harness also has the ability to recognize the completion of CPAS executed by the SAS UUT.

Test Harness

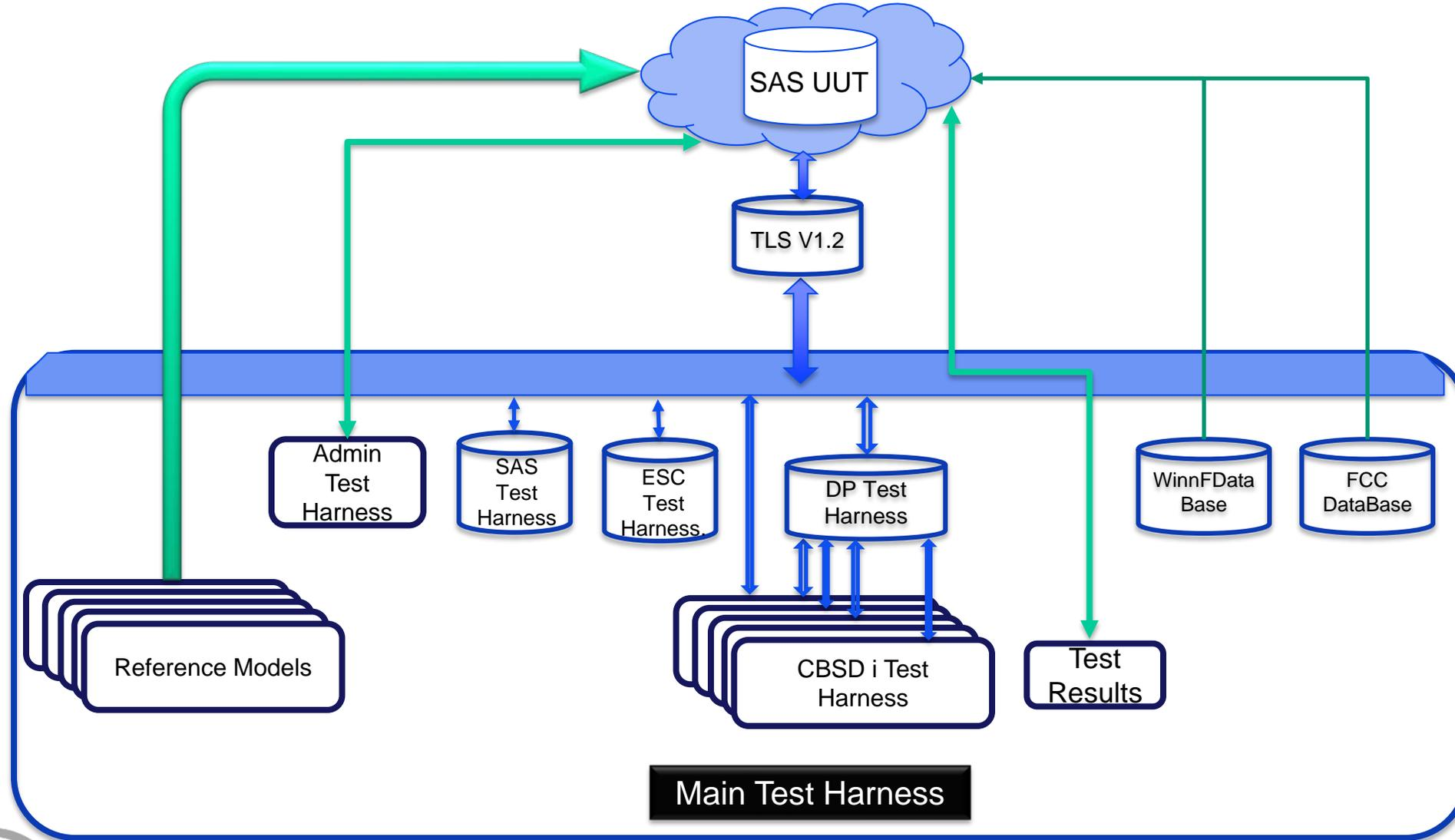

Reference Models

The following Reference Models are used to generate the results as expected by the SAS UUT. These results are used to compare the outputs of SAS UUT functions, and determine the Pass/Fail Criteria of the SAS.

- 1. IAP Reference Model:** To calculate the allocated power using IAP Process
- 2. Pre-IAP Reference Model:** To generate the remaining CBSDs after performing pre-IAP procedure during CPAS.
- 3. DPA Move List Reference Model:** To generate the move list around off-shore and inland DPAs (Dynamic Protection Area) to protect Federal Radars
- 4. Propagation Model Reference Model:** To generate different statistics of ITM and eHATA (NTIA Model) path loss for a given transmitter and receive point

- 5. CBSD Antenna Pattern Reference Model:** To generate the antenna gain of a CBSD transmitter antenna gain at a given direction
- 6. PPA Creation Reference Model:** To generate the maximum PAL Protection Area boundary, given a certain PAL ID, given PAL Channel and a cluster of CBSDs

CPAS Process

The SAS Administrators have agreed to perform the following Coordinated Periodic Activities among SASs (CPAS) every 24 hours at an agreed and pre-determined time (e.g. 12:00am PST), synchronously. The values of T1, T2, and T3 are determined and agreed upon by all SAS administrators

1. At time T1: Each SAS creates a Full Dump Record (all data should be “the state as of T1”), including
 - a. All CBSDs with at least one active grant
 - b. All existing active grants i.e. all grants which should be used in IAP.
 - c. All PPAs
 - d. Location, Antenna characteristics, and Protection levels of all ESC sensors
2. At time T2
 - a. Each SAS pulls Full Dump Record from all other SASs
 - b. Each SAS Synchronizes with all external databases (FCC & WInnForum)
3. Upon completion of step 2, each SAS performs Pre-IAP filtering activities in the following order
 - a. Determine conflict grants, i.e. CBSDs having approved grants from multiple SASs simultaneously, and remove those grants from the rest of process
 - b. Apply Exclusion Zone (EZ) protections; CBSDs within the EZ, with the grants associated to the EZ, are removed from the rest of process for the EZ corresponding channels.
 - PPA,
 - GWPZ
 - Part 90 subpart Z (GWBL stations within 150 km of FSS operating within 3650-3700 MHz),
 - All Inlands federal radars protected by Exclusion Zone.
 - c. Calculate FSS Purge List for all FSS stations with TT&C = ON. The purged CBSDs are removed from the rest of the process
4. Upon completion of step 3, using the exchanged records, All SASs perform the following activities independently:
 - a. Using maxEirp (within requestedOperationParam for CBSDs managed by other SASs if provided, otherwise within operationParam), run IAP Algorithm to protect all non-Federal higher tier protection entities (GWPZ, FSS Co-channel, FSS blocking, PPAs and ESC sensors),
 - b. Using maxEirp (within requestedOperationParam for CBSDs managed by other SASs if provided, otherwise within operationParam), perform DPA Move List Calculation for all offshore and inland DPAs,
5. At Time T3: Each SAS responds to all CBSDs that it manages and require power decrease (termination through *heartbeatResponse*).
6. At time T3 + 240 sec: Each SAS may respond to all CBSDs that it manages and allow power increase, and responds to new grants whose requested *maxEIRP* is approved.

Today's Agenda

Welcome and introductions - Lee Pucker, The Wireless Innovation Forum

Requirements - Andy Clegg, Google

Protocols

- SAS to CBSD - Mike Dolan, Nokia
- SAS to SAS - Yi Hsuan, Google

Test and Certification

- SAS - Masoud Olfat, Federated Wireless
- **CBSD - Awaiz Khan, Ruckus Wireless**

Operations - Richard Bernhardt, WISPA

- CA
- CPI
- Other

Documents & Process pertaining to CBSD testing

WINNF-TS-0122-V1.0.0 CBRS CBSD Test Specification

- WG4 develops and publishes the test cases.
- Functional tests to address requirements from FCC and /or WG1, WG2, WG3
- Testing the protocol (messaging) exchanged between the CBSD/DP and SAS
- Test cases leveraged to create test scripts/code for facilitating execution of the test cases by the test labs.

Published documents available at:

<https://workspace.winnforum.org/higherlogic/ws/public>

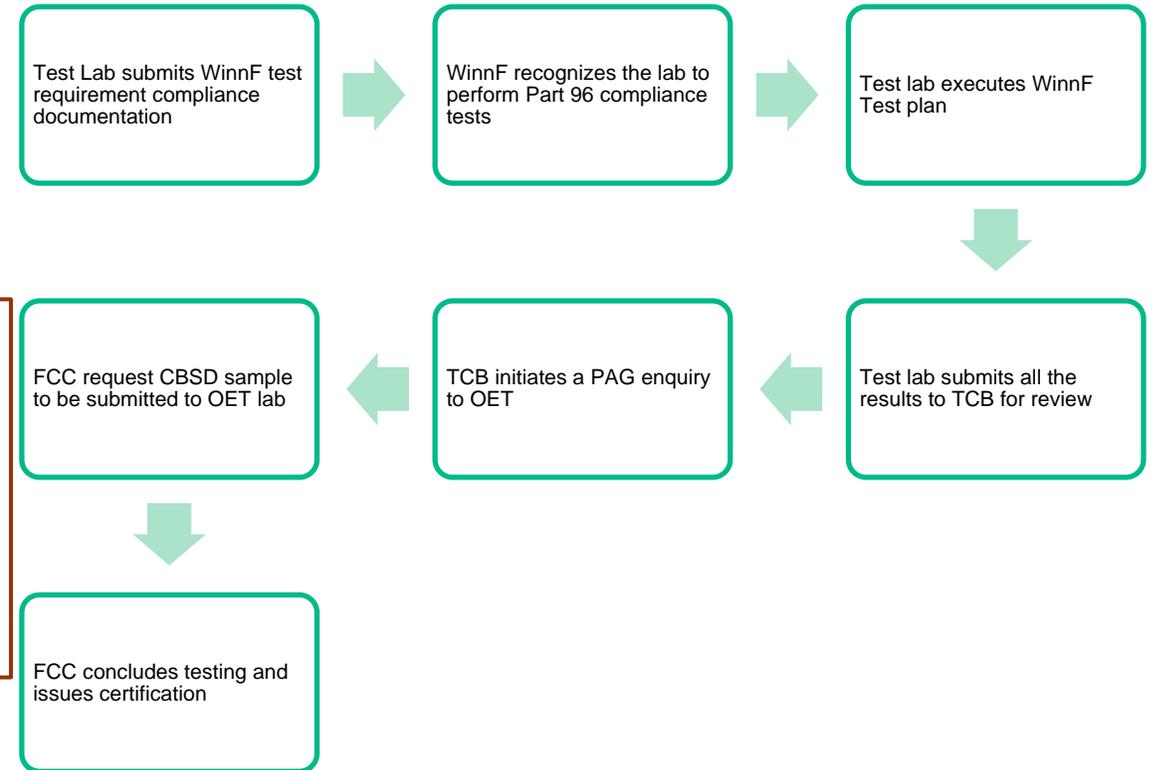

<http://www.cbcrs.wirelessinnovation.org/cbsd-certification-program>

WinnForum Approved CBSD Test Program for FCC Authorized Test Labs

- **Winnforum publishes and maintains test lab requirements that must be met for conducting part 96 compliance testing**
- **Details of the test program can be found at**
<http://www.cbirs.wirelessinnovation.org/cbsd-certification-program>
- **Global database is maintained for all the approved labs**
- **Projected First Wave Certification Timeline:**
- **Training of first wave Test Labs on WinnForum Test Specification and Test Harness will begin in early February(3 sessions planned completed 1)**
 - Training will be required to get accredited to perform WinnForum CBSD Testing
- **Follow on Workshop will be held on how to get accredited: Date TBD**
- **First wave of Test Labs will need to submit WinnForum Authentication Application: ~ March 9, 2018**
- **WinnForum Certification Database soft launched: ~ March 30, 2018**
 - Test Labs and Staff added to database
- **Test Labs receive and test first wave products: ~ April 30, 2018**
- **Need to submit Test Lab Packet to OET for approval: by May 30, 2018**



Test Harness Code Availability

- **SAS Test Harness code has been developed by WINNF WG4-CBSD, by multiple CBSD vendors**
- **Designed to aid FCC certification by implementing all test cases in WINNF-TS-00122**
- **Code is licensed under Apache License 2.0**
- **Code publicly available on GitHub**
- **Final version for WINNF release 1.2 not yet finalized**
- **Implemented in Python 2.7**

SAS Test Harness Components (1)

SAS Test Harness Software

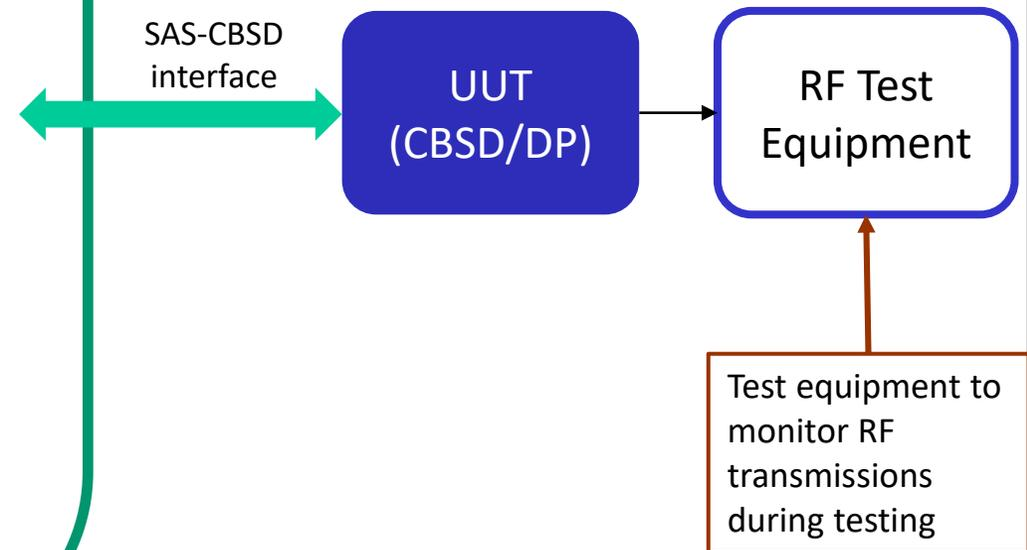

SAS Test Harness Components (2)

SAS Test Harness Software

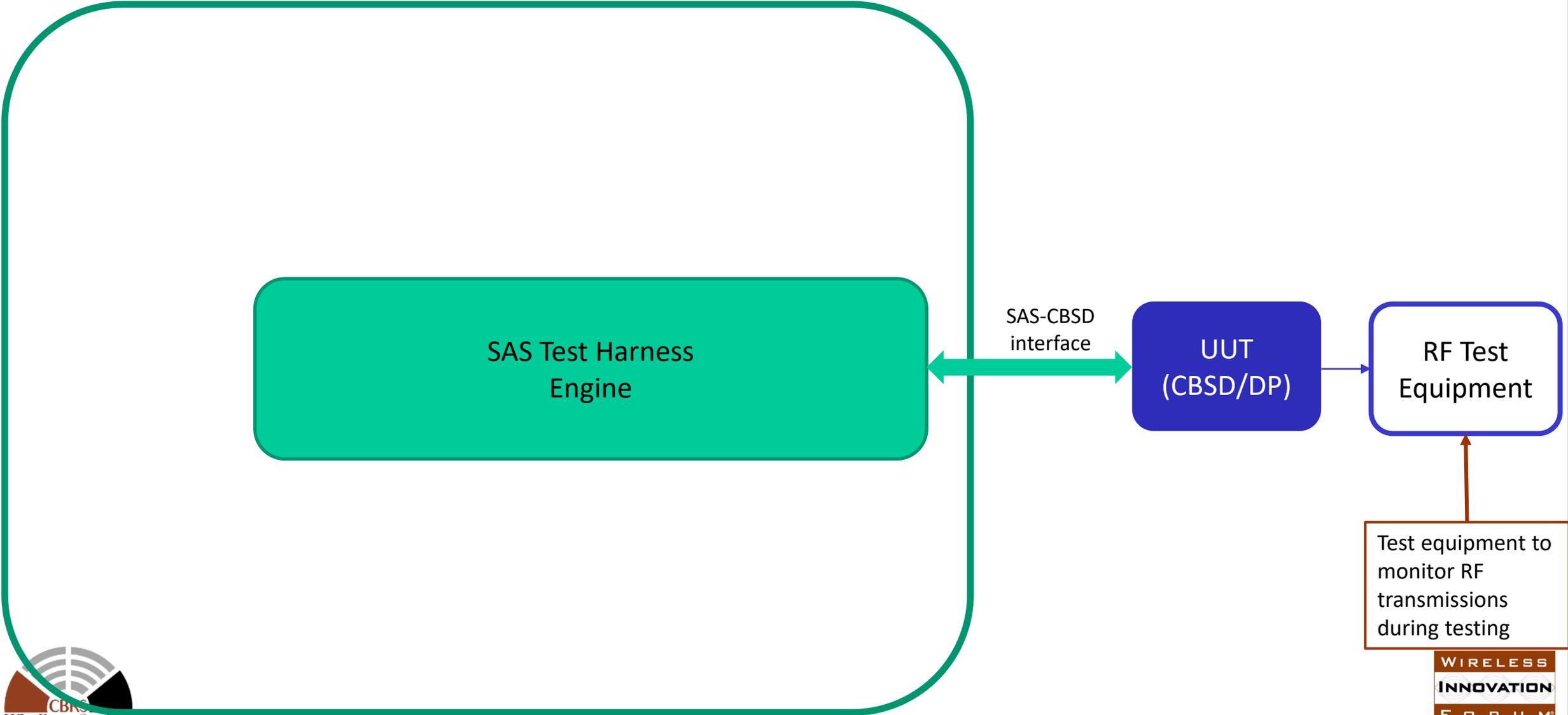

SAS Test Harness Components (3)

SAS Test Harness Software

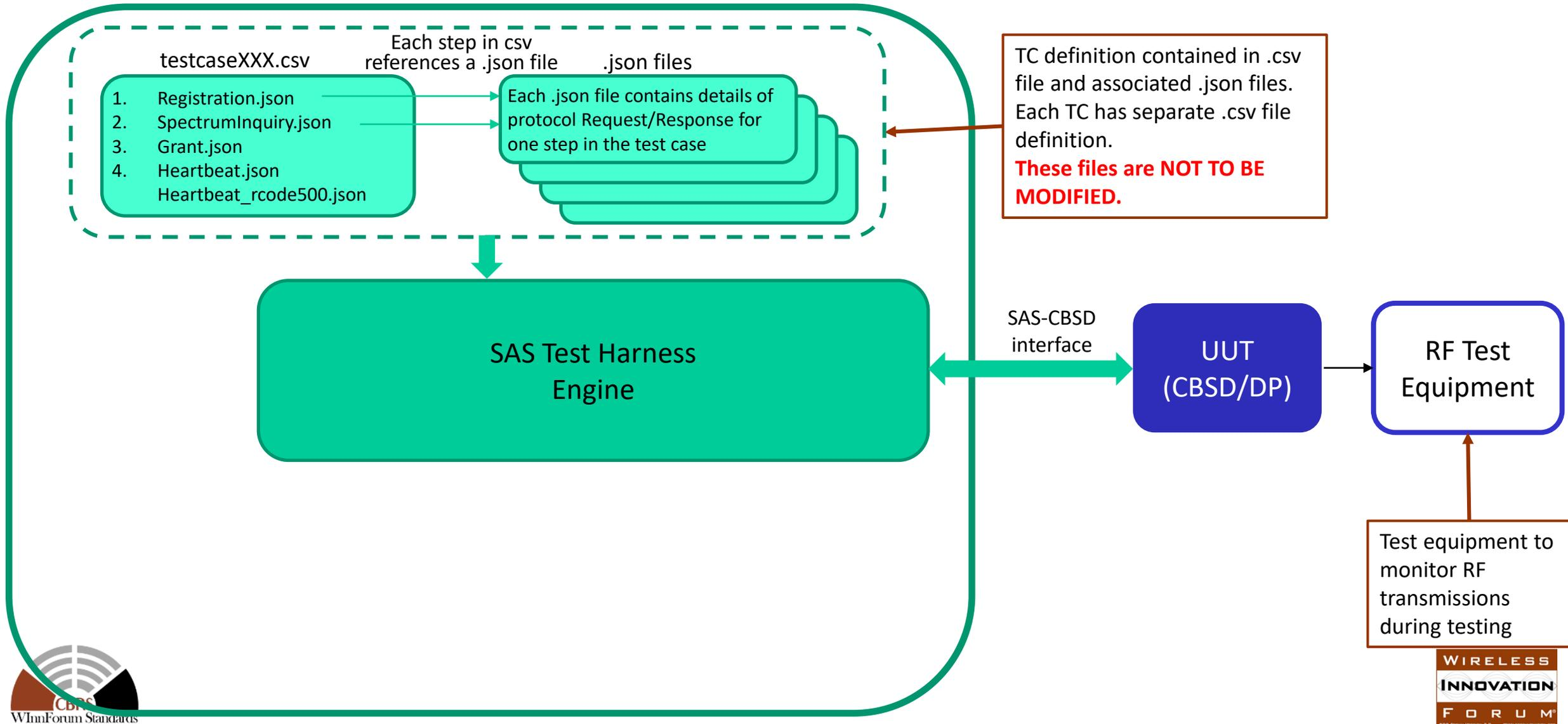

SAS Test Harness Components (4)

SAS Test Harness Software

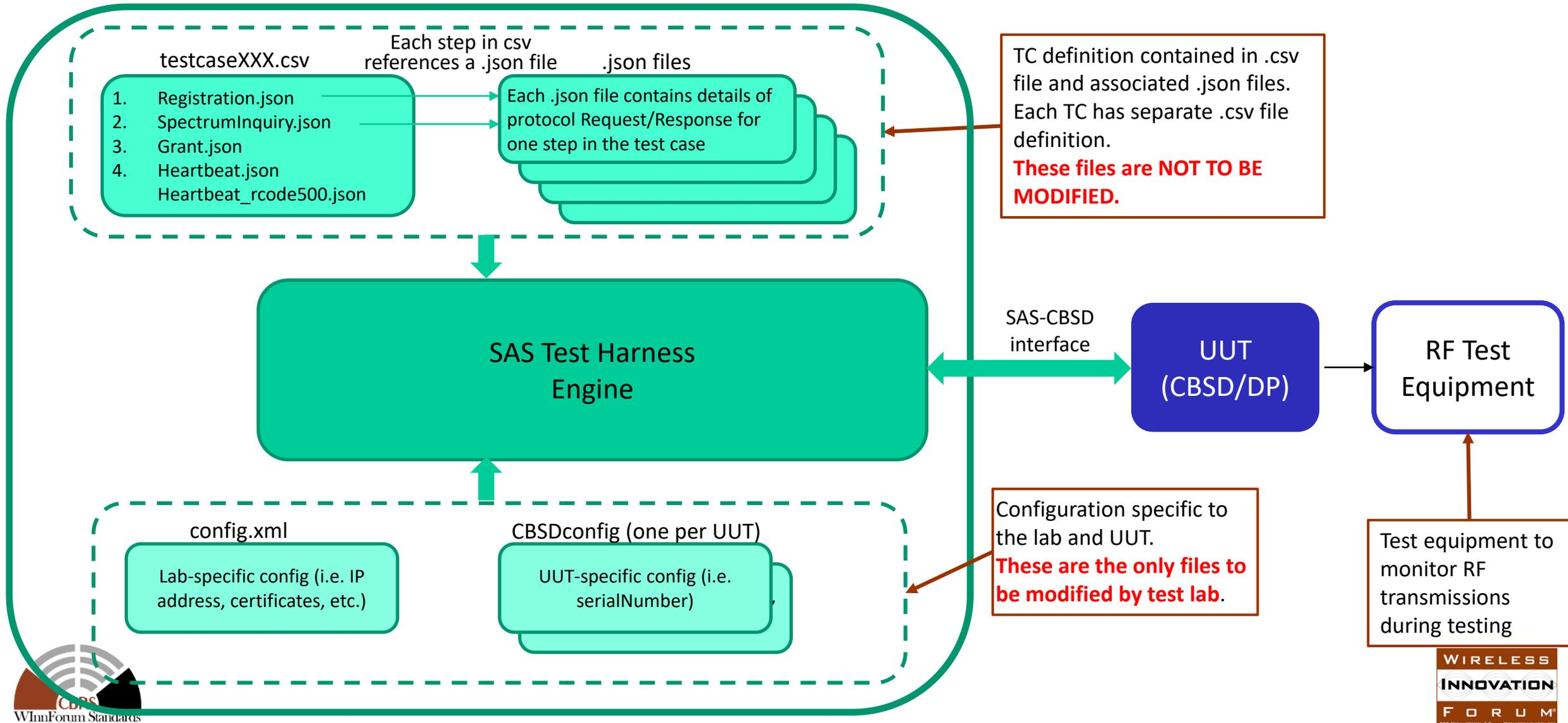

SAS Test Harness Components (5)

SAS Test Harness Software

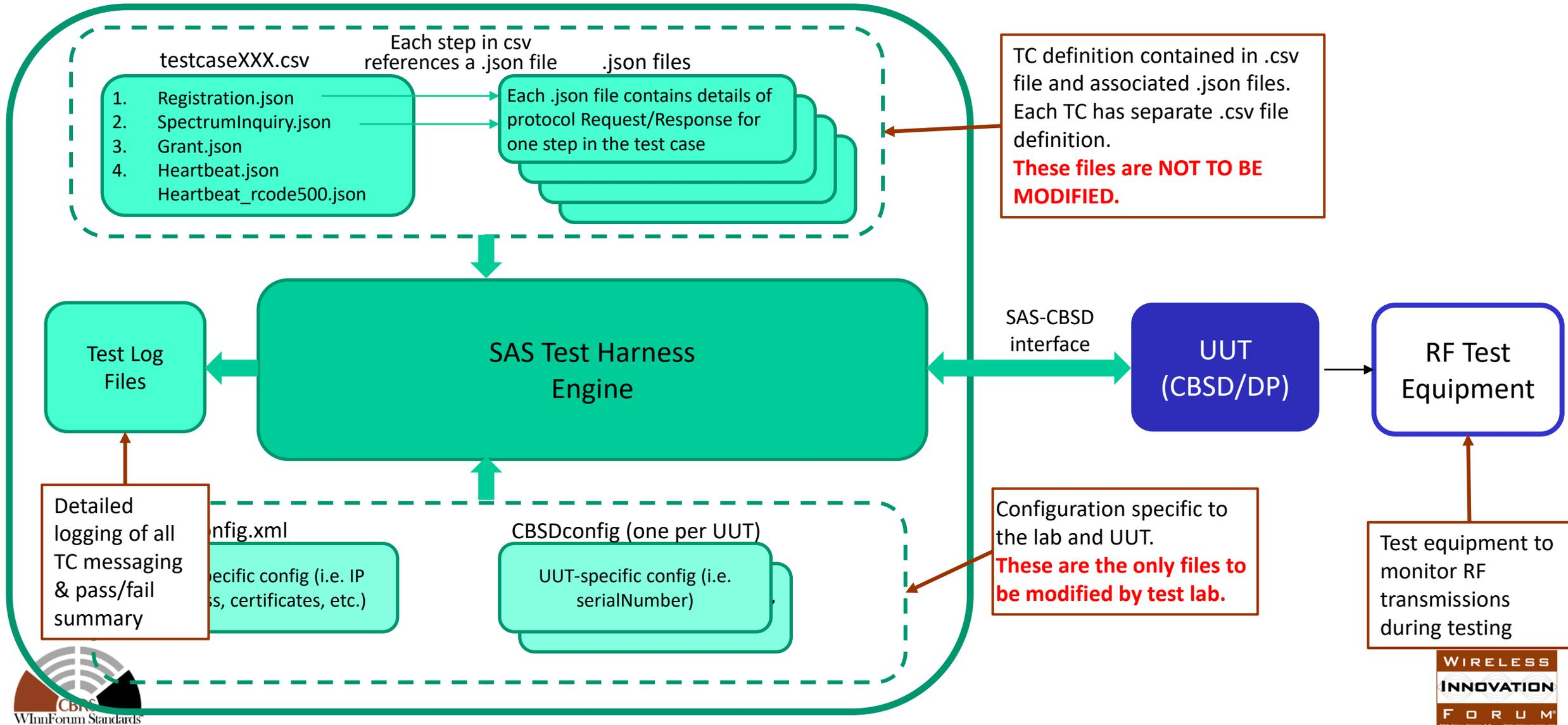

WinnF SAS Test Harness Code Validation Method

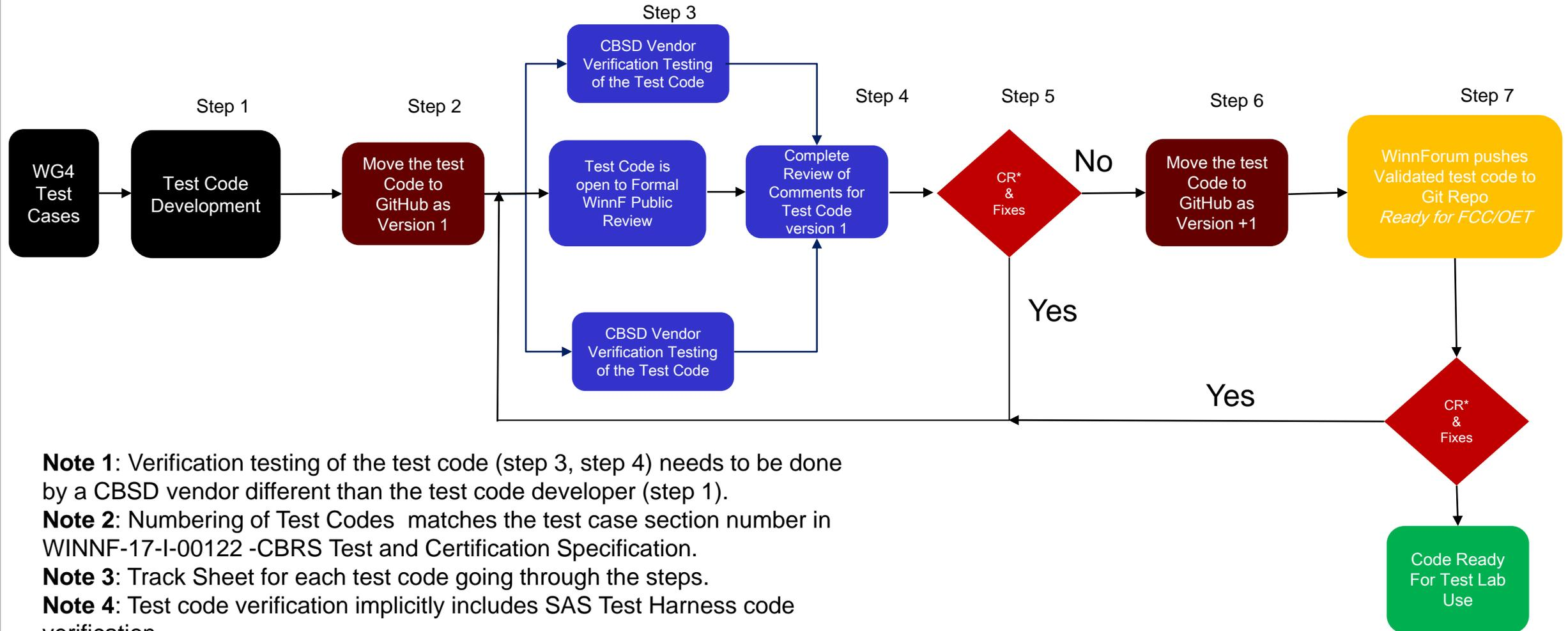

Note 1: Verification testing of the test code (step 3, step 4) needs to be done by a CBSD vendor different than the test code developer (step 1).

Note 2: Numbering of Test Codes matches the test case section number in WINNF-17-I-00122 -CBRS Test and Certification Specification.

Note 3: Track Sheet for each test code going through the steps.

Note 4: Test code verification implicitly includes SAS Test Harness code verification.

Today's Agenda

Welcome and introductions - Lee Pucker, The Wireless Innovation Forum

Requirements - Andy Clegg, Google

Protocols

- SAS to CBSD - Mike Dolan, Nokia
- SAS to SAS - Yi Hsuan, Google

Test and Certification

- SAS - Masoud Olfat, Federated Wireless
- CBSD - Awaiz Khan, Ruckus Wireless

Operations - Richard Bernhardt, WISPA

- CA
- CPI
- Other

PKI Root of Trust Certification

Security and Identification in the CBRS Band



WinnForum Authorized PKI Certification Providers: Digicert and Insta

Public and Private Keys.



Utilization of Certificates and Keys Provides an Aspect of Security in the CBRS Band.

SASs use Certificates.

CPI's use Certificates for Identity.

Protection of Private Keys is Paramount.

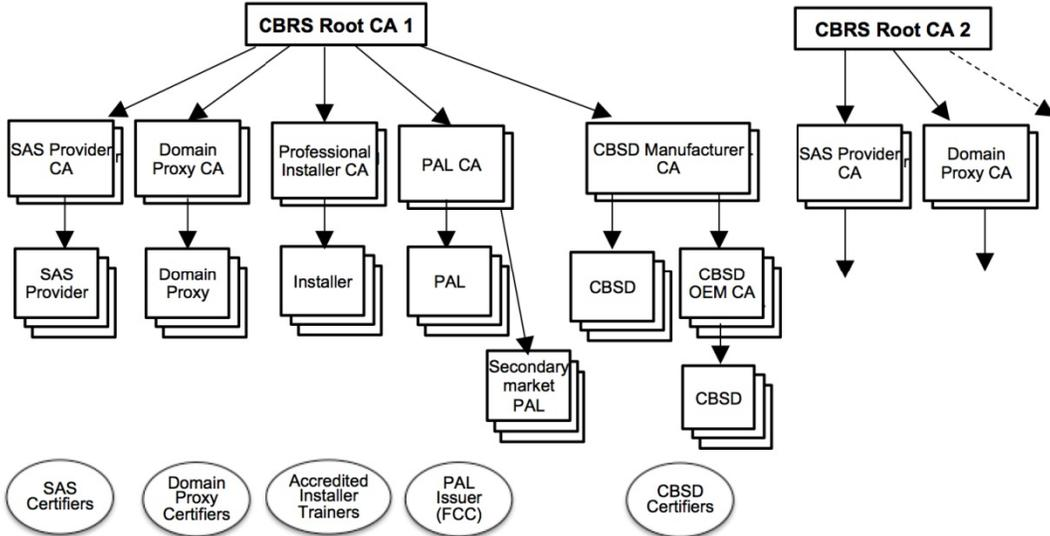

Certified Professional Installers (CPI)

ROLE OF THE CERTIFIED PROFESSIONAL INSTALLER IN CBRS OPERATIONS

Accredited Training Administration Programs - Training and Certification of CPIs

- Provides training-curriculum, testing, certification, updates, keep records and discipline review.
- FCC 47 CFR Part 96 CBRS Rules (Mandatory); WInnForum Standards (Mandatory)
- SAS Specific Information (Optional); Vendor Specific Information (Optional); Other RF Training (Optional)

CPI Responsibilities

- Know about Rules and Standards and implement installations accordingly
- Enter registration data accurately and timely to the SAS; Verify CPI status with CA
- Certify the installation; Stay Current



Who Must Use a CPI?

Category B CBSD Installations

All Category B CBSD installations wherever located require a CPI to install and validate registration information.

Category A CBSD Installations

If a Category A CBSD is installed where it cannot self-geolocate (self report its accurate location and height) and/or where the installation is above 6 meters Height Above Average Terrain (HAAT).

The CPI verifies to the SAS the required registration parameters and information about the CBSD. Without this information the SAS cannot accurately do its job.



GAA Co-Existence

GETTING ALONG ON THE BAND – GAA CO-EXISTENCE

47 CFR Part 96 Governs the Obligations of Co-Existence of GAA Users in CBRS

“General Authorized Access Users operating Category B CBSDS *must make every effort to cooperate* in the selection and use of available frequencies provided by an SAS to minimize the potential for interference and make the most effective use of the authorized facilities. Such users shall coordinate with an SAS before seeking station authorization, and make every effort to ensure that their CBSDs operate at a location, and with technical parameters, that will minimize the potential to cause and receive interference among CBSDs. *Operators of CBSDs suffering from or causing harmful interference are expected to cooperate and resolve interference problems through technological solutions or by other mutually satisfactory arrangements.*”

Many technologies, many use cases, diverse geography, varied power, different distances between CBSDs, regulations and more ... make co-existence behavior vital to the CBRS Band.

WRAP-UP

Resources

Standards and operating policies can be found at: <http://www.cbirs.wirelessinnovation.org/>

This webinar will be posted on the WinnForum You Tube Channel later today:

- <https://www.youtube.com/channel/UCYUeZvOuJTP27OzoKsyys0w>

For more detail on the protocols, see:

- February 23rd 2017 webinar: <https://www.youtube.com/watch?v=vJJFFHmjl8E>

For more information on CBSD test and certification, see:

- August 30, 2017 webinar: https://www.youtube.com/watch?v=qC7Ae_MjQ0Q

To register a new air interface or measurement technology:

- <http://www.cbirs.wirelessinnovation.org/cbirs-technology-registration>

Work on the next standards release is underway

Backlog (Target WG)

- Leasing (WG1)
- Simplification and Optimization of Requirements from Release 1 (WG1)
- Support for Revised Rules as Required (WG1)
- Automated Exception Handling (WG1)
- Enhanced PAL Support (WG3)
- Registration Update (WG3)
- Enhanced Measurement Reporting (WG3)
- PAL Channel Assignment (WG5)
- PAL Coexistence (WG1)

In Progress

- Propagation Model update for Release 1 (WG1)
- International Border Update for Release 1 (WG1)
- Test Case Updates to Release 1 (WG4)
- Simplification and Optimization of Release 1 SAS to CBSD Protocol for Release 2 (WG3)
- Simplification and Optimization of Release 1 SAS to SAS Protocol for Release 2 (WG3)
- GAA Coexistence TR (WG5)

Complete

- CBSD as CPE for Release 2 (WG1)
- GAA Coexistence for Release 2 (WG1)
- Evolution of Propagation Models for Release 2 (WG1)

To get involved in driving the future of CBRS Standards:
<http://www.wirelessinnovation.org/join>